

Chapter 1 Exam A

Name _____

SHORT ANSWER. Write the word or phrase that best completes each statement or answers the question.

Form a conclusion about statistical significance. Do not make any formal calculations. Either use the results provided or make subjective judgments about the results.

- 1) Last year, the average math SAT score for students at one school was 475. The headmaster introduced new teaching methods hoping to improve scores. This year, the mean math SAT score for a sample of students was 481. Is there statistically significant evidence that the new teaching method is effective? If the teaching method had no effect, there would be roughly a 3 in 10 chance of seeing such an increase. Does the result have statistical significance? Why or why not? Does the result have practical significance? 1) _____

Provide an appropriate response.

- 2) Why do you think that cluster sampling is frequently used in practice. 2) _____

Use critical thinking to determine whether the sampling method appears to be sound or is flawed.

- 3) "38% of adults in the United States regularly visit a doctor". This conclusion was reached by a college student after she had questioned 520 randomly selected members of her college. What is wrong with her survey? 3) _____

MULTIPLE CHOICE. Choose the one alternative that best completes the statement or answers the question.

Determine whether the given description corresponds to an observational study or an experiment.

- 4) A stock analyst selects a stock from a group of twenty for investment by choosing the stock with the greatest earnings per share reported for the last quarter. 4) _____
A) Experiment B) Observational study

Identify which of these types of sampling is used: random, stratified, systematic, cluster, convenience.

- 5) The name of each contestant is written on a separate card, the cards are placed in a bag, and three names are picked from the bag. 5) _____
A) Random
B) Cluster
C) Convenience
D) Stratified
E) Systematic

- 6) To avoid working late, a quality control analyst simply inspects the first 100 items produced in a day. 6) _____
A) Systematic
B) Stratified
C) Convenience
D) Cluster
E) Random

SHORT ANSWER. Write the word or phrase that best completes each statement or answers the question.

Provide an appropriate response.

- 7) A lawyer surveyed a simple random sample of his colleagues and asked them whether they were left-handed or right-handed. Is this convenience sample likely to provide results typical of all adults in the United States? Do convenience samples in general provide good results? 7) _____

Identify the sample and population. Also, determine whether the sample is likely to be representative of the population.

- 8) 100,000 randomly selected adults were asked whether they drink at least 48 oz of water each day and only 45% said yes. 8) _____

MULTIPLE CHOICE. Choose the one alternative that best completes the statement or answers the question.

Provide an appropriate response.

- 9) An education expert is researching teaching methods and wishes to interview teachers from a particular school district. She randomly selects ten schools from the district and interviews all of the teachers at the selected schools. Does this sampling plan result in a random sample? Simple random sample? Explain. 9) _____
- A) No; no. The sample is not random because teachers in small schools are more likely to be selected than teachers in larger schools. It is not a simple random sample because some samples are not possible, such as a sample that includes teachers from schools that were not selected.
- B) Yes; yes. The sample is random because all teachers have the same chance of being selected. It is a simple random sample because all samples have the same chance of being selected.
- C) Yes; no. The sample is random because all teachers have the same chance of being selected. It is not a simple random sample because some samples are not possible, such as a sample that includes teachers from schools that were not selected.
- D) No; yes. The sample is not random because teachers in small schools are more likely to be selected than teachers in larger schools. It is a simple random sample because all samples have the same chance of being selected.

Identify the type of observational study (cross-sectional, retrospective, prospective).

- 10) A town obtains current employment data by polling 10,000 of its citizens this month. 10) _____
- A) Prospective B) Retrospective C) Cross-sectional D) None of these

SHORT ANSWER. Write the word or phrase that best completes each statement or answers the question.

Provide an appropriate response.

- 11) Distinguish between categorical and quantitative data. Give an example for each. 11) _____

MULTIPLE CHOICE. Choose the one alternative that best completes the statement or answers the question.

Determine whether the given value is from a discrete or continuous data set.

- 12) The height of 2-year-old maple tree is 28.3 ft. 12) _____
- A) Continuous B) Discrete

Determine which of the four levels of measurement (nominal, ordinal, interval, ratio) is most appropriate.

- 13) Student's grades, A, B, or C, on a test. 13) _____
- A) Interval B) Nominal C) Ordinal D) Ratio

SHORT ANSWER. Write the word or phrase that best completes each statement or answers the question.

Provide an appropriate response.

- 14) Use the data in the table to answer the question. The x -values are amounts of saturated fat (in grams) in various regular two-ounce muffins. The y-values are amounts of saturated fat (in grams) in various "low fat" two-ounce muffins. 14) _____

Amounts of Saturated Fat in Regular and Low-Fat Muffins

x	3.7	4.9	4.3	6.4	4.2	4.5
y	1.2	2.1	2.2	1.9	1.4	2.4

Is each x-value matched with a corresponding y-value? That is, is each x-value associated with the corresponding y-value in some meaningful way? If the x- and y-values are not matched, does it make sense to use the difference between each x-value and the y-value that is in the same column?

- 15) Explain the difference between stratified and cluster sampling. 15) _____

MULTIPLE CHOICE. Choose the one alternative that best completes the statement or answers the question.

Identify which of these types of sampling is used: random, stratified, systematic, cluster, convenience.

- 16) A tax auditor selects every 1000th income tax return that is received. 16) _____
- A) Stratified
 - B) Systematic
 - C) Random
 - D) Cluster
 - E) Convenience

SHORT ANSWER. Write the word or phrase that best completes each statement or answers the question.

Use critical thinking to develop an alternative conclusion.

- 17) A study shows that adults who work at their desk all day weigh more than those who do not. Conclusion: Desk jobs cause people to gain weight. 17) _____

Provide an appropriate response.

- 18) Would an observational study or an experiment be more appropriate to investigate the effects on humans of a substance known to be toxic? Explain. 18) _____

MULTIPLE CHOICE. Choose the one alternative that best completes the statement or answers the question.

Determine whether the given value is a statistic or a parameter.

- 19) After inspecting all of 55,000 kg of meat stored at the Wurst Sausage Company, it was found that 45,000 kg of the meat was spoiled. 19) _____
- A) Statistic
 - B) Parameter

SHORT ANSWER. Write the word or phrase that best completes each statement or answers the question.

Provide an appropriate response.

- 20) Explain what is meant by the term "confounding" and give an example of an experiment in which confounding is likely to be a problem. 20) _____

MULTIPLE CHOICE. Choose the one alternative that best completes the statement or answers the question.

Determine whether the given value is from a discrete or continuous data set.

- 21) The temperature of a cup of coffee is 67.3°F. 21) _____
A) Continuous B) Discrete

Solve the problem.

- 22) On a test, 74% of the questions are answered correctly. If 111 questions are correct, how many questions are on the test? 22) _____
A) 37 B) 67 C) 150 D) 74

Identify the type of observational study (cross-sectional, retrospective, prospective).

- 23) Researchers collect data by interviewing athletes who have won olympic gold medals from 1992 to 2008. 23) _____
A) Retrospective B) Cross-sectional
C) Prospective D) None of these

SHORT ANSWER. Write the word or phrase that best completes each statement or answers the question.

Form a conclusion about statistical significance. Do not make any formal calculations. Either use the results provided or make subjective judgments about the results.

- 24) Charlie's teacher claims that he does not study and just guesses on exams. On an exam with 201 true-false questions, Charlie answered 53.7% of the questions correctly. Calculations using these results show that if he were really just guessing, there would be roughly 1 chance in 7 that he would do this well. Is there statistically significant evidence against the teacher's claim that Charlie is just guessing? Why or why not? 24) _____

MULTIPLE CHOICE. Choose the one alternative that best completes the statement or answers the question.

Provide an appropriate response.

- 25) A psychology student wishes to investigate differences in political opinions between business majors and political science majors at her college. She randomly selects 100 students from the 260 business majors and 100 students from the 180 political science majors. Does this sampling plan result in a random sample? Simple random sample? Explain. 25) _____
A) Yes; yes. The sample is random because all students have the same chance of being selected. It is a simple random sample because all samples of size 200 have the same chance of being selected.
B) No; yes. The sample is not random because political science majors have a greater chance of being selected than business majors. It is a simple random sample because all samples of size 200 have the same chance of being selected.
C) No; no. The sample is not random because political science majors have a greater chance of being selected than business majors. It is not a simple random sample because some samples are not possible, such as a sample consisting of 50 business majors and 150 political science majors.
D) Yes; no. The sample is random because all students have the same chance of being selected. It is not a simple random sample because some samples are not possible, such as a sample consisting of 50 business majors and 150 political science majors.

Answer Key

Testname: CHAPTER 1 EXAM A

- 1) No. The new mean SAT score is not substantially higher. Even if the new teaching method had no effect, a small increase such as this could easily be seen just by chance. No. The increase is not sufficient to be of practical significance.
- 2) Answers will vary. Possible answer: Cluster sampling can save time and money and be more efficient, especially when the clusters are geographically far apart from each other. For example, if a researcher wishes to interview a sample of high school teachers in a school district, it will be easier to interview all the teachers at a few schools than to interview a few teachers from many different schools.
- 3) The sample is biased. College students are not representative of the U.S. population as a whole.
- 4) B
- 5) A
- 6) C
- 7) Yes. There is nothing about left-handedness or right-handedness that would affect being one of the lawyer's colleagues. In terms of left- or right-handedness, a simple random sample of the lawyer's colleagues is likely to be representative of all adults in the United States. Convenience samples in general do not tend to provide good results as the sample is often not representative of a broader population.
- 8) Sample: the 100,000 selected adults; population: all adults; representative
- 9) C
- 10) C
- 11) Qualitative data can be separated into categories that are distinguished by nonnumeric characteristics. Quantitative data consist of numbers representing counts or measurements. Examples will vary.
- 12) A
- 13) C
- 14) The x-values are not matched with the y-values, so it does not make sense to use the differences between each x-value and the y-value that is in the same column.
- 15) In both cluster sampling and stratified sampling, sub-groups (clusters or strata) are formed. However, in stratified sampling, all strata are used and a sample is selected from each strata. In cluster sampling, a sample of the clusters is first selected, then all members of those clusters are selected.
- 16) B
- 17) Desk job workers are confined to their chairs for most of their work day. Other jobs require standing or walking around which burns calories. It is probably the lack of exercise that causes higher weights, not the desk job itself. Avoid causality altogether by saying lack of walking and exercise is associated with higher weights.
- 18) An observational study would be more appropriate. An experiment would not be appropriate because it would be unethical to administer as a treatment a substance known to be toxic. However a retrospective observational study, for example, could be carried out by examining records from the past and observing the effects where the substance had been accidentally ingested.
- 19) B
- 20) Confounding occurs in an experiment when the effects of two or more variables cannot be distinguished from each other. Examples will vary. One example is that of a school district that conducts a study regarding whether the science laboratory approach or the computer simulation approach is better for learning chemistry among seniors. A standardized achievement test is used to measure learning, and the results of the two schools are compared. Unless controlled in the study, two confounding variables are teaching expertise and student motivation.
- 21) A
- 22) C
- 23) A
- 24) No; The exam result of 53.7% is not substantially greater than 50%. Even if Charlie were just guessing, he could easily do this well just by chance.
- 25) C

Chapter 1 Exam B

Name _____

SHORT ANSWER. Write the word or phrase that best completes each statement or answers the question.

Form a conclusion about statistical significance. Do not make any formal calculations. Either use the results provided or make subjective judgments about the results.

- 1) A manufacturer of laptop computers claims that only 1% of their computers are defective. 1) _____
In a sample of 600 computers, it was found that 3% were defective. If the proportion of defectives were really only 1%, there would be less than 1 chance in 1000 of getting such a large proportion of defective laptops in the sample. Is there statistically significant evidence against the manufacturer's claim? Why or why not?

MULTIPLE CHOICE. Choose the one alternative that best completes the statement or answers the question.

Identify which of these types of sampling is used: random, stratified, systematic, cluster, convenience.

- 2) A pollster uses a computer to generate 500 random numbers, then interviews the voters corresponding to those numbers. 2) _____
A) Convenience
B) Systematic
C) Cluster
D) Random
E) Stratified

SHORT ANSWER. Write the word or phrase that best completes each statement or answers the question.

Provide an appropriate response.

- 3) A hip hop radio show broadcast in the city of Puddelton asked people to call in and express their opinions on the new mayor. Are the results likely to be representative of all adults in Puddelton? Of all listeners to the hip hop show? Why or why not? 3) _____

- 4) Use the data in the table to answer the question. The x -values are amounts of saturated fat (in grams) in various regular two-ounce muffins. The y-values are amounts of saturated fat (in grams) in various "low fat" two-ounce muffins. 4) _____

Amounts of Saturated Fat in Regular and Low-Fat Muffins

x	4.5	3.5	3.7	5.2	4.9	3.9
y	1.2	2.1	2.2	1.8	1.6	2.2

Note that the table lists measured amounts of saturated fat in two different types of muffin. Given these data, what issue can be addressed by conducting a statistical analysis of the values?

- 5) At a school there are two different math classes of the same age. The two classes have different teachers. The school principal is interested in gauging the effectiveness of two different teaching methods and asks each teacher to try one of the methods. At the end of the semester both classes are given the same test and the results are compared. In this experiment, what is the variable of interest? Give some examples of variables which could be confounding variables. 5) _____

MULTIPLE CHOICE. Choose the one alternative that best completes the statement or answers the question.

Determine whether the given value is a statistic or a parameter.

- 6) After taking the first exam, 15 of the students dropped the class. 6) _____
A) Statistic B) Parameter

Determine which of the four levels of measurement (nominal, ordinal, interval, ratio) is most appropriate.

- 7) Student's grades, A, B, or C, on a test. 7) _____
A) Ratio B) Ordinal C) Nominal D) Interval
- 8) Nationalities of survey respondents. 8) _____
A) Ratio B) Nominal C) Interval D) Ordinal

SHORT ANSWER. Write the word or phrase that best completes each statement or answers the question.

Provide an appropriate response.

- 9) The table shows the weights (in pounds) and monthly incomes (in dollars) of nine randomly selected women between the ages of 18 and 65. Assume that the x -values are the weights and the y-values are the monthly incomes. 9) _____

Weight (lb)	113	132	155	122	166	140	118	129	185
Monthly Income (dollars)	1420	3650	5475	2310	4710	2910	1720	2460	4115

If we use statistical methods to conclude that there is a correlation (or relationship or association) between the weights of women and their monthly incomes, can we conclude that by increasing her weight a woman can increase her monthly income?

MULTIPLE CHOICE. Choose the one alternative that best completes the statement or answers the question.

Identify which of these types of sampling is used: random, stratified, systematic, cluster, convenience.

- 10) A tax auditor selects every 1000th income tax return that is received. 10) _____
A) Stratified
B) Convenience
C) Random
D) Cluster
E) Systematic

SHORT ANSWER. Write the word or phrase that best completes each statement or answers the question.

Provide an appropriate response.

- 11) A lawyer surveyed a simple random sample of his colleagues and asked them whether they were left-handed or right-handed. Is this convenience sample likely to provide results typical of all adults in the United States? Do convenience samples in general provide good results? 11) _____
- 12) A teacher was interested in knowing how much tax people pay in the United States. She selected a simple random sample of her friends and asked them about their taxes. Is this sample likely to be representative of all adults in the United States? 12) _____
- 13) Would an observational study or an experiment be more appropriate to investigate the effects on humans of a substance known to be toxic? Explain. 13) _____

Form a conclusion about statistical significance. Do not make any formal calculations. Either use the results provided or make subjective judgments about the results.

- 14) Charlie's teacher claims that he does not study and just guesses on exams. On an exam with 201 true-false questions, Charlie answered 53.7% of the questions correctly. Calculations using these results show that if he were really just guessing, there would be roughly 1 chance in 7 that he would do this well. Is there statistically significant evidence against the teacher's claim that Charlie is just guessing? Why or why not? 14) _____

Provide an appropriate response.

- 15) A coach uses a new technique in training middle distance runners. The times, in seconds, for 8 different athletes to run 800 meters before and after this training are shown below. 15) _____

Athlete	A	B	C	D	E	F	G	H
Before	115.2	114	116.4	119.8	110.9	112.4	111.5	117.3
After	112.9	112.7	114	120.6	109.1	109.1	107.9	113.4

Does the conclusion that the technique is effective appear to be supported with statistical significance? Does the conclusion that the technique is effective appear to have practical significance?

- 16) Why do you think that cluster sampling is frequently used in practice. 16) _____

Form a conclusion about statistical significance. Do not make any formal calculations. Either use the results provided or make subjective judgments about the results.

- 17) Last year, the average math SAT score for students at one school was 475. The headmaster introduced new teaching methods hoping to improve scores. This year, the mean math SAT score for a sample of students was 481. Is there statistically significant evidence that the new teaching method is effective? If the teaching method had no effect, there would be roughly a 3 in 10 chance of seeing such an increase. Does the result have statistical significance? Why or why not? Does the result have practical significance? 17) _____

MULTIPLE CHOICE. Choose the one alternative that best completes the statement or answers the question.

Determine whether the given description corresponds to an observational study or an experiment.

- 18) A political pollster reports that his candidate has a 10% lead in the polls with 10% undecided. 18) _____
A) Experiment B) Observational study

Identify the type of observational study (cross-sectional, retrospective, prospective).

- 19) A town obtains current employment data by polling 10,000 of its citizens this month. 19) _____
A) Cross-sectional B) Prospective C) Retrospective D) None of these

Determine whether the given description corresponds to an observational study or an experiment.

- 20) A doctor performs several diagnostic tests to determine the reason for a patient's illness. 20) _____
A) Observational study B) Experiment

SHORT ANSWER. Write the word or phrase that best completes each statement or answers the question.

Identify the sample and population. Also, determine whether the sample is likely to be representative of the population.

- 21) An employee at the local ice cream parlor asks three customers if they like chocolate ice cream. 21) _____

MULTIPLE CHOICE. Choose the one alternative that best completes the statement or answers the question.

Identify which of these types of sampling is used: random, stratified, systematic, cluster, convenience.

22) A market researcher selects 500 people from each of 10 cities. 22) _____

- A) Convenience
- B) Cluster
- C) Stratified
- D) Random
- E) Systematic

23) 49, 34, and 48 students are selected from the Sophomore, Junior, and Senior classes with 496, 348, and 481 students respectively. 23) _____

- A) Stratified
- B) Cluster
- C) Convenience
- D) Systematic
- E) Random

Solve the problem.

24) A gardener has 75 clients, 45% of whom are businesses. Find the number of business clients. 24) _____

- A) 41 clients
- B) 34 clients
- C) 36 clients
- D) 73 clients

Determine whether the given description corresponds to an observational study or an experiment.

25) A marketing firm does a survey to find out how many people use a product. Of the one hundred people contacted, fifteen said they use the product. 25) _____

- A) Experiment
- B) Observational study

Answer Key

Testname: CHAPTER 1 EXAM B

- 1) Yes. If the claimed proportion of defectives of 1% were correct, there would be a very small likelihood of getting 3% defectives in the sample. The sample rate of 3% is significantly greater than the claimed rate of 1%.
- 2) D
- 3) No. A hip hop show is likely to attract a younger audience. Listeners to the show will not be representative of all adults in Puddleton so a sample from those listeners, however well selected, will not be representative. No, this sample will not be representative of all listeners to the show because it is a voluntary response sample - listeners themselves choose whether to respond. Those with stronger opinions are more likely to respond so the sample is unlikely to be representative of all listeners to the show.
- 4) Given the context of the data, we could address the issue of whether the two types of muffin provide the same amounts of saturated fat, or whether there is a difference between the two types of muffin.
- 5) The variable of interest is the teaching method. Possible confounding variables are "skill of teacher" (is one teacher better than the other?), "aptitude of students" (do the two classes have students of the same ability?), "amount of study time" (does one class have students who are more conscientious?).
- 6) B
- 7) B
- 8) B
- 9) No. If a correlation (or relationship or association) is found, this doesn't mean that one variable is the cause of another. Larger weights do not cause higher incomes, but tend to be associated with higher incomes because both weight and income are associated with a third variable, age. Older women tend to be heavier and to have higher incomes than younger women.
- 10) E
- 11) Yes. There is nothing about left-handedness or right-handedness that would affect being one of the lawyer's colleagues. In terms of left- or right-handedness, a simple random sample of the lawyer's colleagues is likely to be representative of all adults in the United States. Convenience samples in general do not tend to provide good results as the sample is often not representative of a broader population.
- 12) No. In terms of income, the teacher's friends are unlikely to be representative of all adults in the United States. So a sample from this group, however well selected, is unlikely to be representative of all adults in the United States.
- 13) An observational study would be more appropriate. An experiment would not be appropriate because it would be unethical to administer as a treatment a substance known to be toxic. However a retrospective observational study, for example, could be carried out by examining records from the past and observing the effects where the substance had been accidentally ingested.
- 14) No; The exam result of 53.7% is not substantially greater than 50%. Even if Charlie were just guessing, he could easily do this well just by chance.
- 15) Yes. Almost all runners have considerably faster times after the training. Yes. The differences appear to be substantial.
- 16) Answers will vary. Possible answer: Cluster sampling can save time and money and be more efficient, especially when the clusters are geographically far apart from each other. For example, if a researcher wishes to interview a sample of high school teachers in a school district, it will be easier to interview all the teachers at a few schools than to interview a few teachers from many different schools.
- 17) No. The new mean SAT score is not substantially higher. Even if the new teaching method had no effect, a small increase such as this could easily be seen just by chance. No. The increase is not sufficient to be of practical significance.
- 18) B
- 19) A
- 20) B
- 21) Sample: the 3 selected customers; population: all customers; not representative
- 22) C
- 23) A
- 24) B
- 25) B

Chapter 2 Exam A

Name _____

SHORT ANSWER. Write the word or phrase that best completes each statement or answers the question.

Provide an appropriate response.

- 1) Create an example displaying data in a pie chart. Display the same data in a Pareto chart. 1) _____
 Which graph is more effective? List at least two reasons in support of your choice.

Use the given data to construct a frequency distribution.

- 2) A school district performed a study to find the main causes leading to its students dropping out of school. Thirty cases were analyzed, and a primary cause was assigned to each case. The causes included unexcused absences (U), illness (I), family problems (F), and other causes (O). The results for the thirty cases are listed below: 2) _____

U U U I F O O U I F
 F O U I I F I I O U
 I F F U U I I O F U

Construct a table summarizing the frequency distribution of the primary causes leading to student dropout.

Cause	Frequency

Provide an appropriate response.

- 3) Use the high closing values of Naristar Inc. stock from the years 1992 - 2003 to construct a time-series graph. (Let $x = 0$ represent 1992 and so on.) Identify a trend. 3) _____

Year	High	Year	High
1992	48	1998	62
1993	53	1999	60
1994	47	2000	68
1995	55	2001	42
1996	58	2002	51
1997	61	2003	78

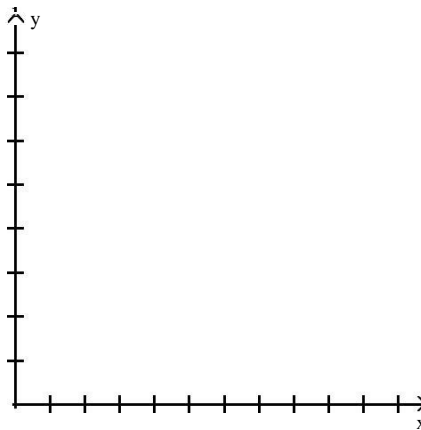

MULTIPLE CHOICE. Choose the one alternative that best completes the statement or answers the question.

Use the given paired data to construct a scatterplot.

4) x -1 -4 -3 -3 -7 4 2 9 -4 -2
 y -3 -6 -4 -9 3 1 1 1 -6 -3

4) _____

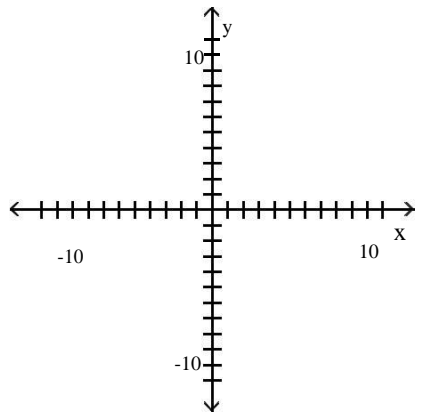

A)

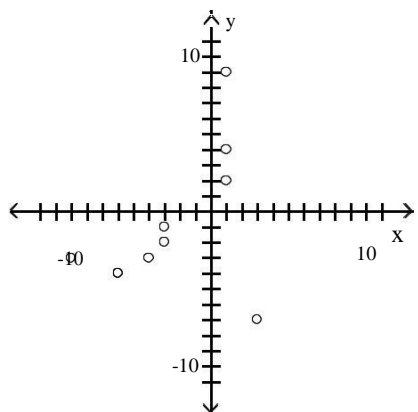

C)

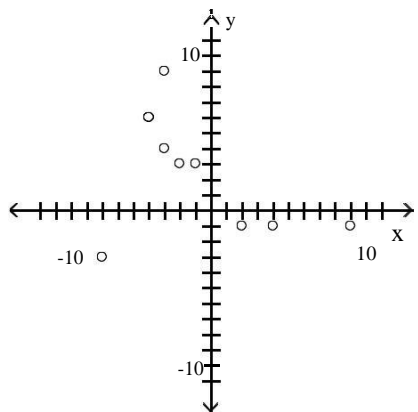

B)

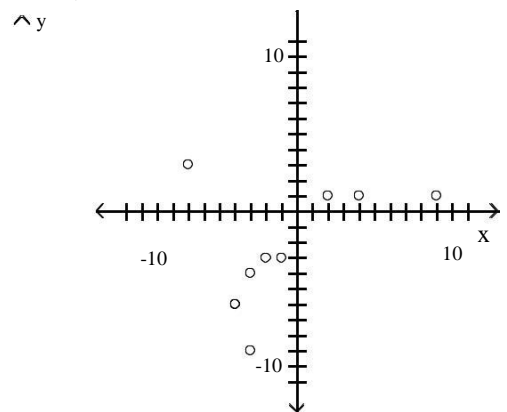

D)

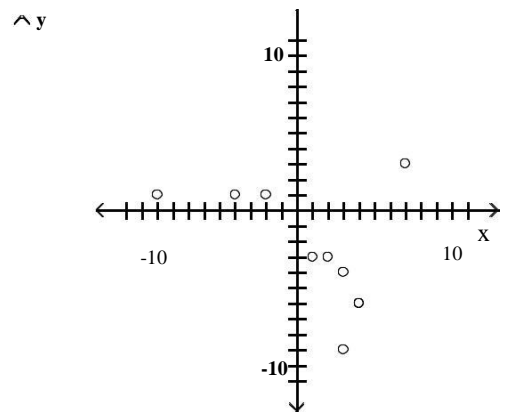

Provide an appropriate response.

- 5) A nurse measured the blood pressure of each person who visited her clinic. Following is a relative-frequency histogram for the systolic blood pressure readings for those people aged between 25 and 40. The blood pressure readings were given to the nearest whole number. Approximately what percentage of the people aged 25-40 had a systolic blood pressure reading between 110 and 119 inclusive?

5) _____

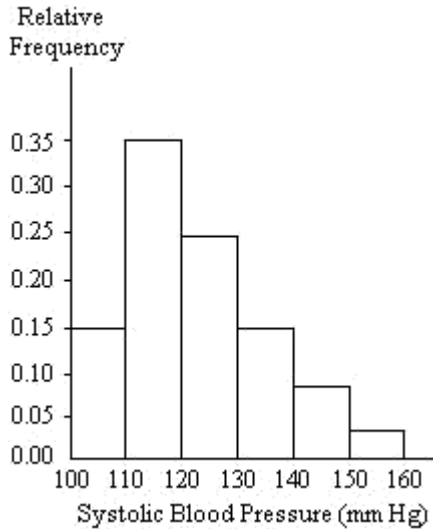

- A) 0.35% B) 3.5% C) 30% D) 35%

- 6) A nurse measured the blood pressure of each person who visited her clinic. Following is a relative-frequency histogram for the systolic blood pressure readings for those people aged between 25 and 40. The blood pressure readings were given to the nearest whole number. Approximately what percentage of the people aged 25-40 had a systolic blood pressure reading between 110 and 139 inclusive?

6) _____

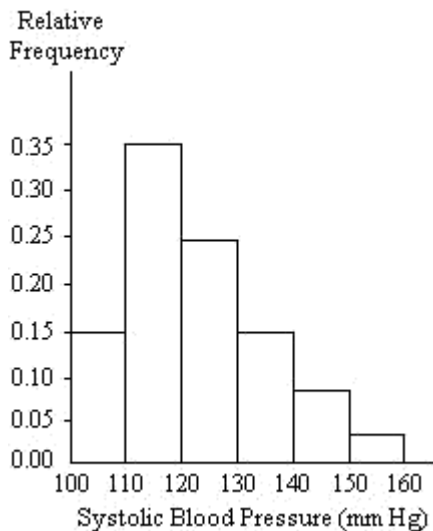

- A) 75% B) 89% C) 59% D) 39%

SHORT ANSWER. Write the word or phrase that best completes each statement or answers the question.

- 7) Describe at least two advantages to using stemplots rather than frequency distributions. 7) _____

MULTIPLE CHOICE. Choose the one alternative that best completes the statement or answers the question.

Solve the problem.

8) The Kappa Iota Sigma Fraternity polled its members on the weekend party theme. The vote was as follows: six for toga, four for hayride, eight for beer bash, and two for masquerade. Display the vote count in a Pareto chart.

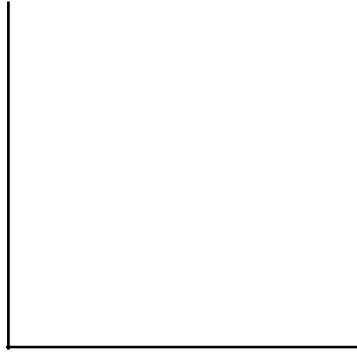

A)

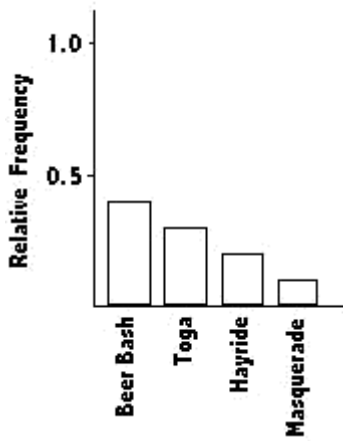

B)

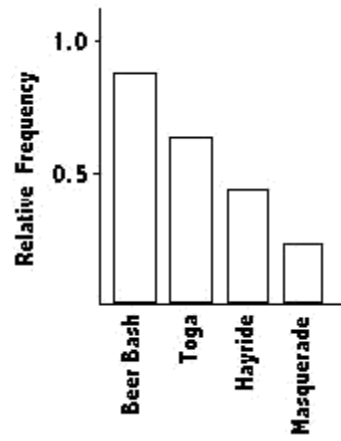

C)

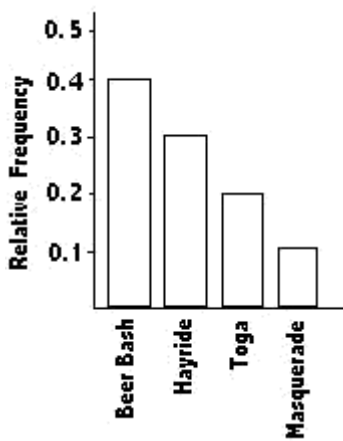

D)

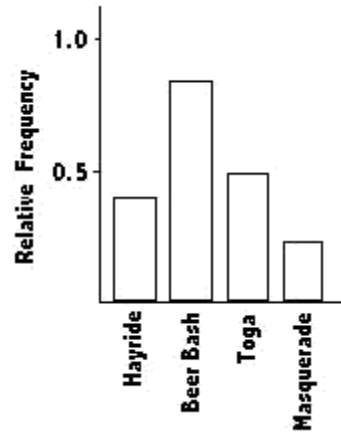

Construct the dotplot for the given data.

9) A store manager counts the number of customers who make a purchase in his store each day. The data are as follows. 9) _____

10 11 8 14 7 10 10 11 8 7

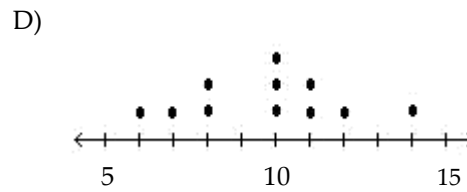
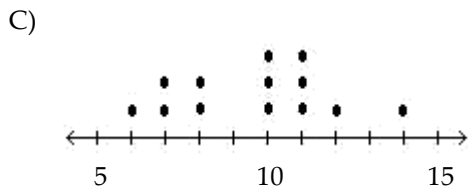
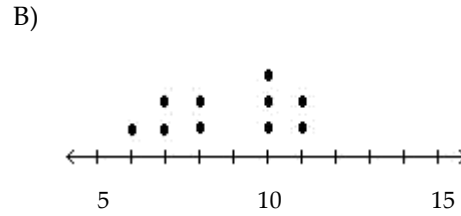
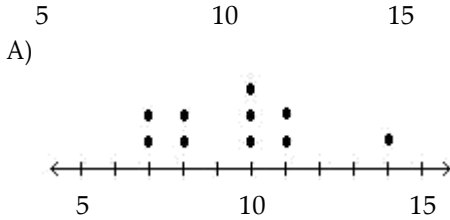
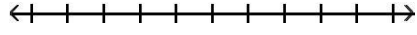

Use the data to create a stemplot.

10) The following data show the number of laps run by each participant in a marathon. 10) _____

46 65 55 43 51 48 57 30 43 49 32 56

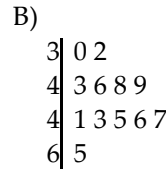
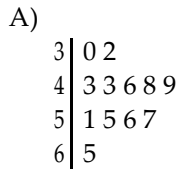

Provide an appropriate response.

11) The frequency distribution below summarizes employee years of service for Alpha Corporation. 11) _____

Find the class boundaries for class 26-30.

Years of service	Frequenc y
1-5	5
6-10	20
11-15	25
16-20	10
21-25	5
26-30	3

A) 26.5, 30.5

B) 26.5, 29.5

C) 25.5, 30.5

D) 25.5, 20.5

Construct the cumulative frequency distribution that corresponds to the given frequency distribution.

12)

12) _____

Speed	Number of cars
0-29	4
30-59	16
60-89	60
90-119	20

A)

Speed	Cumulative Frequency
Less than 30	4
Less than 60	20
Less than 90	80
Less than 120	100

B)

Speed	Cumulative Frequency
Less than 30	0.04
Less than 60	0.20
Less than 90	0.80
Less than 120	1.00

C)

Speed	Cumulative Frequency
0-29	4
30-59	20
60-89	80
90-119	100

D)

Speed	Cumulative Frequency
Less than 30	100
Less than 60	80
Less than 90	82
Less than 120	4

Provide an appropriate response.

13) The following frequency distribution analyzes the scores on a math test. Find the class midpoint of scores interval 40-59. 13) _____

Scores	Number of students
40-59	2
60-75	4
76-82	6
83-94	15
95-99	5

A) 50.5

B) 48.5

C) 49.5

D) 49.0

- 14) The histogram below represents the number of television sets per household for a sample of U.S. households. What is the minimum number of households having the same number of television sets? 14) _____

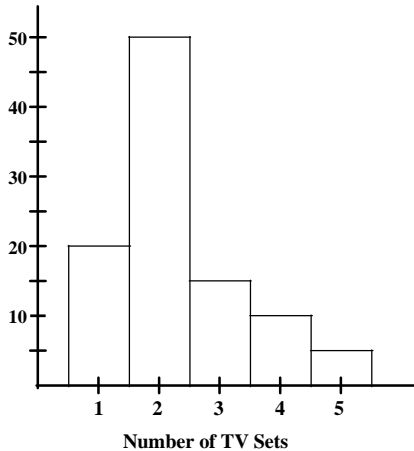

- A) 1 B) 100 C) 20 D) 5

Use the data to create a stemplot.

- 15) The weights of 22 members of the varsity football team are listed below. 15) _____

144 152 142 151 160 152 131 164 141 153 140
144 175 156 147 133 172 159 135 159 148 171

A)

```

13| 1 3 5
14| 0 1 2 4 4 7 8
15| 1 2 2 3 6 9 9
16| 0 4
17| 1 2 5
  
```

B)

```

13| 1 3 5
14| 1 2 2 3 6 9 9
15| 0 1 2 4 4 7 8
16| 0 4
17| 1 2 5
  
```

Provide an appropriate response.

- 16) A nurse measured the blood pressure of each person who visited her clinic. Following is a relative-frequency histogram for the systolic blood pressure readings for those people aged between 25 and 40. The blood pressure readings were given to the nearest whole number. What class width was used to construct the relative frequency distribution?

16) _____

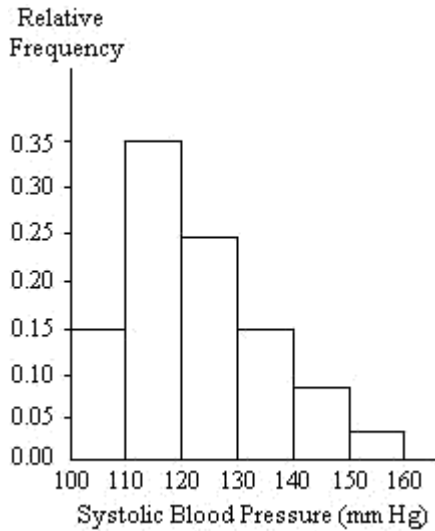

- A) 11 B) 9 C) 10 D) 100

- 17) The following frequency distribution analyzes the scores on a math test. Find the class boundaries of scores interval 95-99.

17) _____

Scores	Number of students
40-59	2
60-75	4
76-82	6
83-94	15
95-99	5

- A) 94.5, 100.5 B) 95.5, 100.5 C) 95.5, 99.5 D) 94.5, 99.5

Use the given paired data to construct a scatterplot.

- 18) x 0.51 0.02 0.14 0.29 0.34 0.8 0.47 0.71
 y 0.31 0.46 -0.12 0.34 -0.05 0.8 0.35 0.47

18) _____

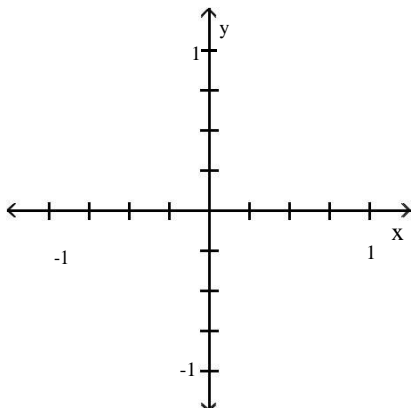

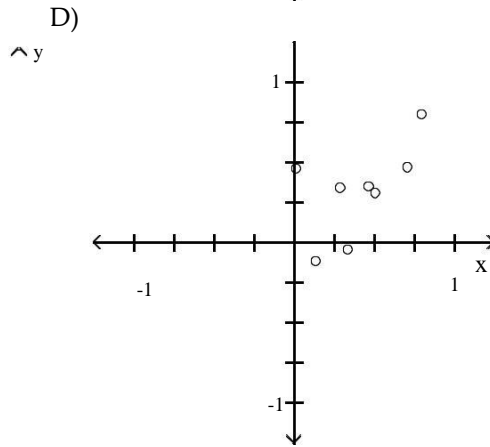
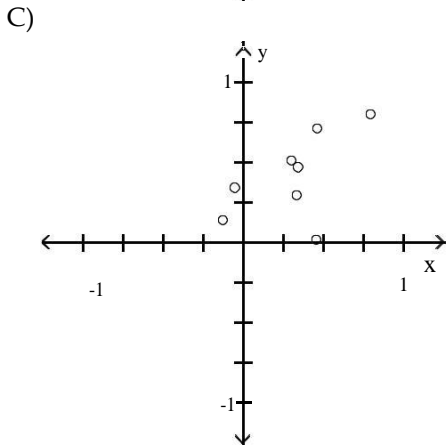
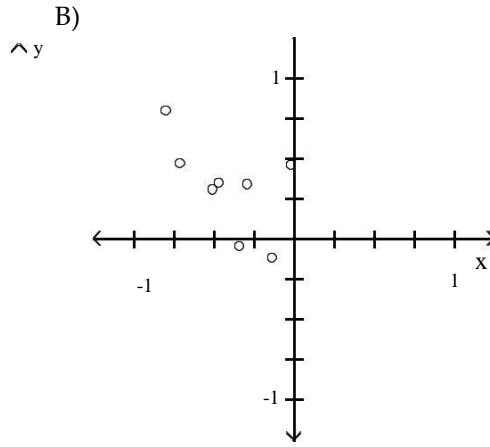
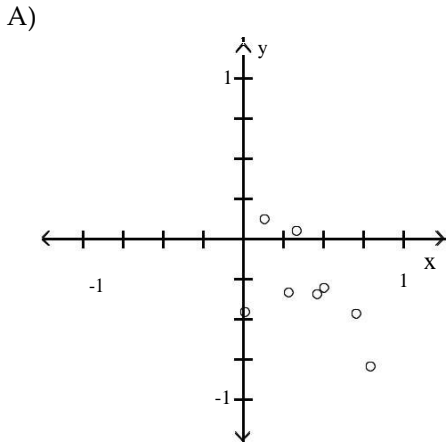

Construct the cumulative frequency distribution that corresponds to the given frequency distribution.

19)

19) _____

Weight (oz)	Number of Stones
1.2-1.6	5
1.7-2.1	2
2.2-2.6	5
2.7-3.1	5
3.2-3.6	13

A)

Weight (oz)	Cumulative Frequency
1.2-1.6	5
1.7-2.1	7
2.2-2.6	12
2.7-3.1	17
3.2-3.6	30

B)

Weight (oz)	Cumulative Frequency
Less than 2.2	7
Less than 3.2	17
Less than 3.7	30

C)

Weight (oz)	Cumulative Frequency
Less than 1.7	5
Less than 2.2	7
Less than 2.7	12
Less than 3.2	17
Less than 3.7	30

D)

Weight (oz)	Cumulative Frequency
Less than 1.7	5
Less than 2.2	7
Less than 2.7	12
Less than 3.2	17
Less than 3.7	28

SHORT ANSWER. Write the word or phrase that best completes each statement or answers the question.

Use the given data to construct a frequency distribution.

20) The following figures represent Jennifer's monthly charges for long distance telephone calls for the past twelve months. 20) _____

7.12 10.40 14.70 18.24
10.48 16.47 7.53 15.45
13.04 15.48 13.33 12.56

Construct a frequency distribution with 4 classes.

Charges	Frequency

Solve the problem.

21) The data shows the roundtrip mileage that 43 randomly selected students drive to school each day. Construct a frequency polygon. Applying a loose interpretation of the requirements for a normal distribution, do the mileages appear to be normally distributed? Why or why not? 21) _____

Miles	Frequency
10-14	0
15-19	6
20-24	9
25-29	21
30-34	7

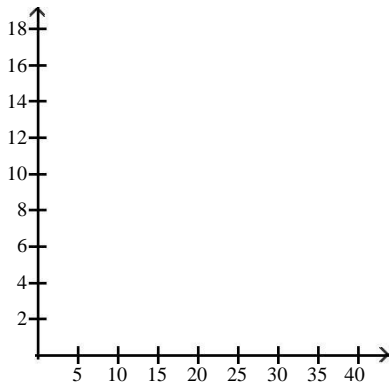

Provide an appropriate response.

22) The graph below shows the number of car accidents occurring in one city in each of the years 2001 through 2006. The number of accidents dropped in 2003 after a new speed limit was imposed. Does the graph distort the data? How would you redesign the graph to be less misleading? 22) _____

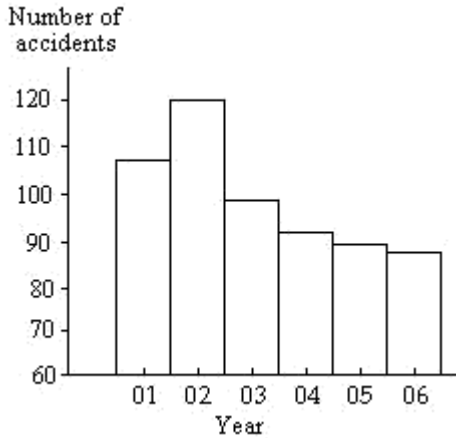

MULTIPLE CHOICE. Choose the one alternative that best completes the statement or answers the question.

Use the data to create a stemplot.

23) The attendance counts for this season's basketball games are listed below. 23) _____

227 239 215 219
221 233 229 233
235 228 245 231

A)

```

21 | 5 9
22 | 1 7 8 9
23 | 1 3 3 5 9
24 | 5
    
```

B)

```

21 | 5 7 9
22 | 1 8 9
23 | 1 3 3 5 9
24 | 5
    
```

Provide an appropriate response.

24) The frequency distribution below summarizes employee years of service for Alpha Corporation. 24) _____
Find the class midpoint for class 1-5.

Years of service	Frequency
1-5	5
6-10	20
11-15	25
16-20	10
21-25	5
26-30	3

A) 3.5

B) 3.0

C) 5.0

D) 2.5

SHORT ANSWER. Write the word or phrase that best completes each statement or answers the question.

25) In a survey, 26 voters were asked their ages. The results are shown below. Construct a histogram to represent the data (with 5 classes beginning with a lower class limit of 19.5 and a class width of 10). What is the approximate age at the center?

25) _____

43 56 28 63 67 66 52 48 37 51 40 60 62
66 45 21 35 49 32 53 61 53 69 31 48 59

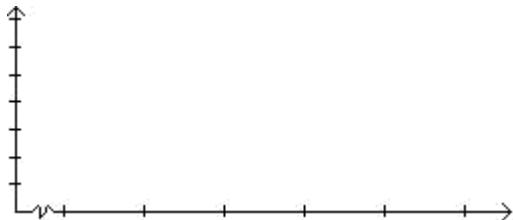

Answer Key

Testname: CHAPTER 2 EXAM A

1) Answers will vary. The answer should include the fact that pie charts are better for showing categories that are parts of a whole, whereas Pareto charts are better for displaying relative importance among categories.

2)

Cause	Frequency
U	9
I	9
F	7
O	5

3) Trend: Answers will vary. Possible answer: Except for a drop in high closing value in 1994, there was a steady rise through 2000, after which there was a sharp drop in 2001 followed by increases through 2003.

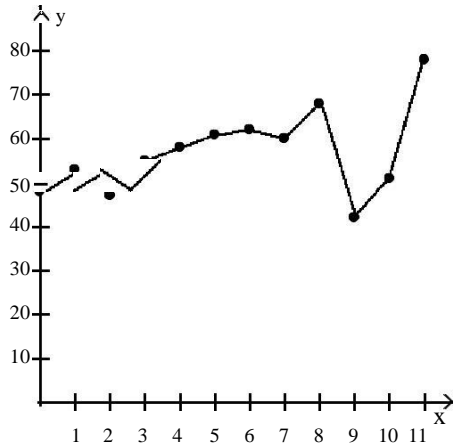

4) B

5) D

6) A

7) Answers will vary. Possible answer: The shape of a distribution can readily be seen. The plot can be drawn quicker, since class width need not be calculated.

8) A

9) A

10) A

11) C

12) A

13) C

14) D

15) A

16) C

17) D

18) D

19) C

20)

Charges	Frequency
7.00-9.99	2
10.00-12.99	3
13.00-15.99	5
16.00-18.99	2

Answer Key

Testname: CHAPTER 2 EXAM A

- 21) The frequency polygon appears to roughly approximate a normal distribution. The frequencies increase to a maximum and then decrease, and the graph is symmetric with the left half being roughly a mirror image of the right half.

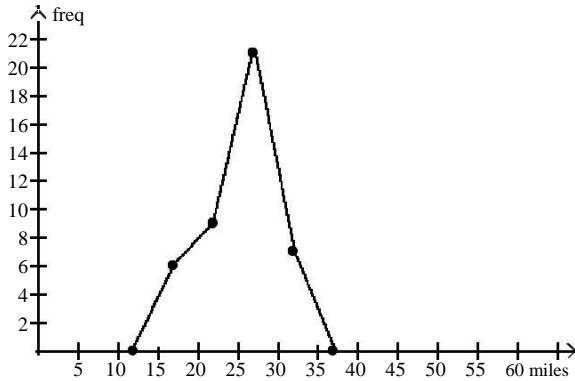

- 22) The graph distorts the data because the the vertical scale starts at 60 rather than 0, giving the impression of a large difference in the number of accidents, when actually the number of accidents only varies from 90 to 120. To make the graph less misleading, change the vertical scale so that it begins at 0 and increases in increments of 20.
- 23) A
- 24) B
- 25) The approximate age at the center is 50.

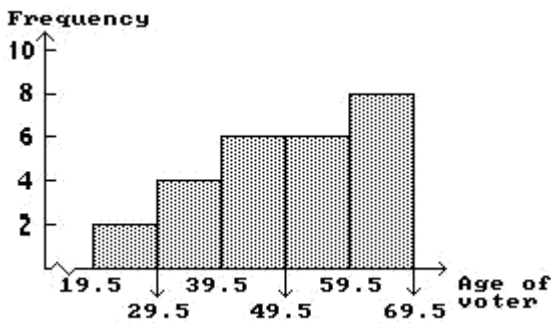

Chapter 2 Exam B

Name _____

MULTIPLE CHOICE. Choose the one alternative that best completes the statement or answers the question.

Provide an appropriate response.

- 1) The histogram below represents the number of television sets per household for a sample of U.S. households. What is the minimum number of households having the same number of television sets? 1) _____

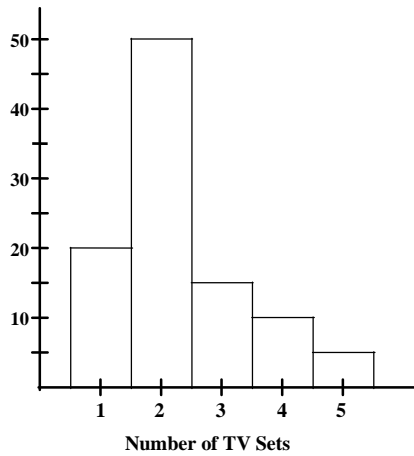

- A) 5 B) 1 C) 20 D) 100

Use the data to create a stemplot.

- 2) The following data consists of the weights (in pounds) of 15 randomly selected women and the weights of 15 randomly selected men. Construct a back-to-back stemplot for the data. 2) _____

Women: 128 150 118 166 142
 122 137 110 175 152
 145 126 139 111 170

Men: 140 153 199 186 169
 136 176 162 196 155
 173 190 141 166 153

A)

Men	Women
	110 1 8
	122 6 8
6	137 9
1 0	142 5
5 3 3	150 2
9 6 2	166
6 3	170 5
6	18
9 6 0	19

B)

Men	Women
	110 1
	122 6 8
6	137 9
1 0	142 5
5 3 3	150 2 4
9 6 2	166
6 3	170 5
9 6	18
9 6	19

Construct the dotplot for the given data.

3) Attendance records at a school show the number of days each student was absent during the year. 3) _____
 The days absent for each student were as follows.

0 2 3 4 2 3 4 6 7 2 3 4 6 9 8

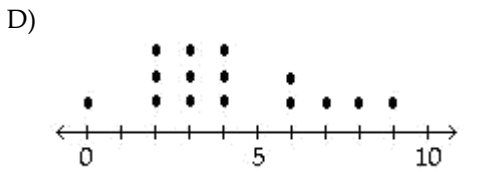
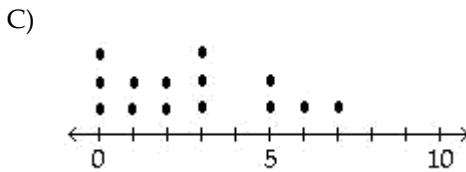
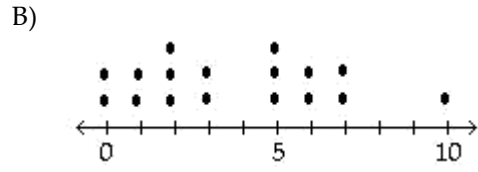
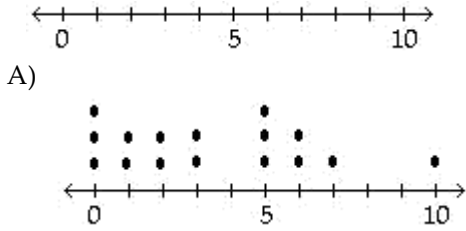

SHORT ANSWER. Write the word or phrase that best completes each statement or answers the question.

Provide an appropriate response.

4) In a survey, 20 people were asked how many magazines they had purchased during the previous year. The results are shown below. Construct a histogram to represent the data. 4) _____
 Use 4 classes with a class width of 10, and begin with a lower class limit of -0.5. What is the approximate amount at the center?

6 15 3 36 25 18 12 18 5 30
 24 7 0 22 33 24 19 4 12 9

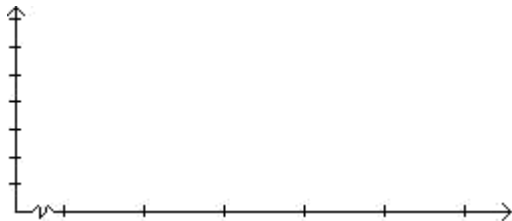

MULTIPLE CHOICE. Choose the one alternative that best completes the statement or answers the question.

5) The frequency distribution below summarizes the home sale prices in the city of Summerhill for the month of June. Determine the width of each class. 5) _____

(Sale price in thousand \$)	Frequency
80.0 - 110.9	2
111.0 - 141.9	5
142.0 - 172.9	7
173.0 - 203.9	10
204.0 - 234.9	3
235.0 - 265.9	1

A) 61

B) 31

C) 28

D) 30

6) A nurse measured the blood pressure of each person who visited her clinic. Following is a relative-frequency histogram for the systolic blood pressure readings for those people aged between 25 and 40. The blood pressure readings were given to the nearest whole number. Approximately what percentage of the people aged 25-40 had a systolic blood pressure reading between 110 and 139 inclusive?

6) _____

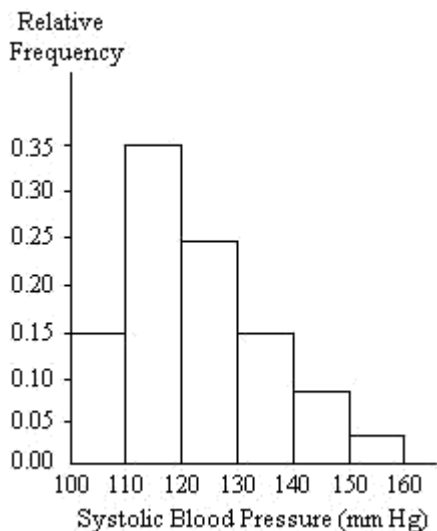

- A) 59% B) 39% C) 89% D) 75%

7) The following frequency distribution analyzes the scores on a math test. Find the class midpoint of scores interval 95-99.

7) _____

Scores	Number of students
40-59	2
60-75	4
76-82	6
83-94	15
95-99	5

- A) 97.5 B) 97.0 C) 96.5 D) 98.0

Use the data to create a stemplot.

8) The ages of the 45 members of a track and field team are listed below. Construct an expanded stemplot with about 8 rows.

8) _____

21 18 42 35 32 21 44 25 38 48 14 19 23 22 28
 32 34 27 31 17 16 41 37 22 24 33 32 21 26 30
 22 27 32 30 20 18 17 21 15 26 36 31 40 16 25

A)

```

1| 4
1| 5 6 6 7 7 8 8 9
2| 0 1 1 1 1 2 2 3 4
2| 5 5 6 6 7 7 8
3| 0 0 1 1 2 2 2 3 4
3| 5 6 7 8
4| 0 1 2 4
4| 8
  
```

B)

```

1| 4 5
1| 5 6 6 7 7 8 8 9
2| 0 1 1 1 1 2 2 3 4 5 5
2| 5 5 6 6 7 7 8
3| 0 0 1 1 2 2 2 3 4 5
3| 5 6 7 8
4| 0 1 2 4
4| 8
  
```

SHORT ANSWER. Write the word or phrase that best completes each statement or answers the question.

Provide an appropriate response.

- 9) Suppose that a data set has a minimum value of 24 and a maximum of 79 and that you want 5 classes. Explain how to find the class width for this frequency table. What happens if you mistakenly use a class width of 11 instead of 12? 9) _____

MULTIPLE CHOICE. Choose the one alternative that best completes the statement or answers the question.

- 10) A nurse measured the blood pressure of each person who visited her clinic. Following is a relative-frequency histogram for the systolic blood pressure readings for those people aged between 25 and 40. The blood pressure readings were given to the nearest whole number. Approximately what percentage of the people aged 25-40 had a systolic blood pressure reading between 110 and 119 inclusive? 10) _____

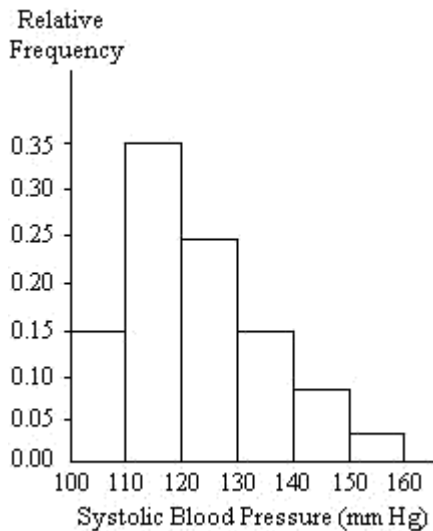

- A) 35% B) 0.35% C) 3.5% D) 30%

Solve the problem.

- 11) The Kappa Iota Sigma Fraternity polled its members on the weekend party theme. The vote was as follows: six for toga, four for hayride, eight for beer bash, and two for masquerade. Display the vote count in a Pareto chart. 11) _____
- vote count in a Pareto chart.

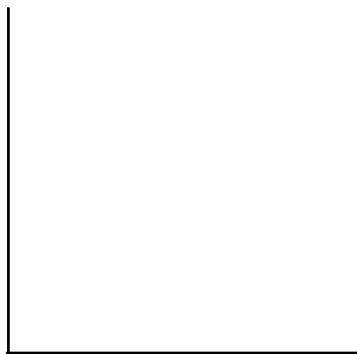

A)

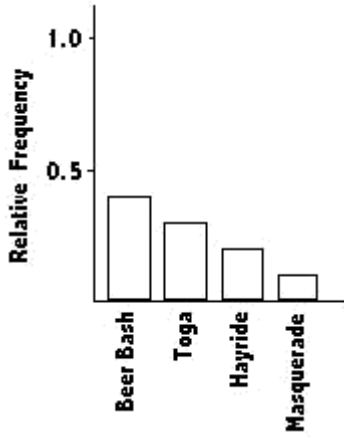

B)

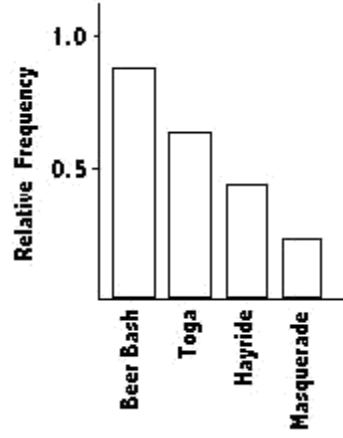

C)

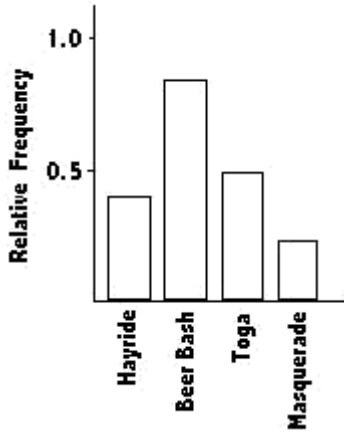

D)

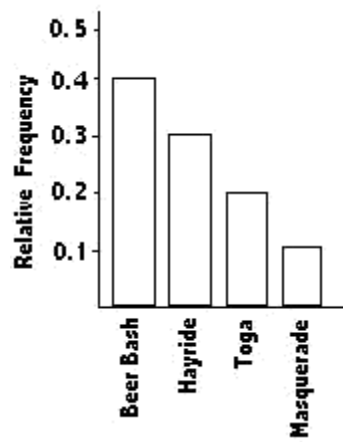

Use the data to create a stemplot.

12) The following data show the number of laps run by each participant in a marathon.

46 65 55 43 51 48 57 30 43 49 32 56

12) _____

A)

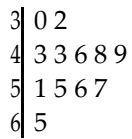

B)

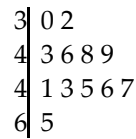

Construct the dotplot for the given data.

- 13) A manufacturer records the number of errors each work station makes during the week. The data are as follows. 13) _____

6 3 2 3 5 2 0 2 5 4 2 0 1

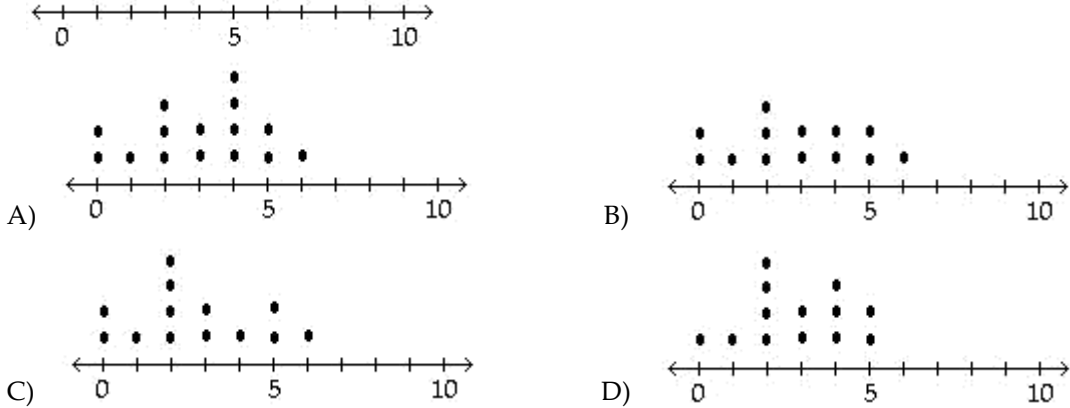

Provide an appropriate response.

- 14) The following frequency distribution analyzes the scores on a math test. Find the class boundaries of scores interval 40-59. 14) _____

Scores	Number of students
40-59	2
60-75	4
76-82	6
83-94	15
95-99	5

- A) 39.5, 59.5 B) 40.5, 59.5 C) 39.5, 58.5 D) 40.5, 58.5

SHORT ANSWER. Write the word or phrase that best completes each statement or answers the question.

Use the given data to construct a frequency distribution.

- 15) Kevin asked some of his friends how many hours they had worked during the previous week at their after-school jobs. The results are shown below. 15) _____

5 6 5 4 5 5 9 8 5 3 7 6
6 7 5 6 7 5 6 8 6 7 8 4

Construct a frequency distribution. Use 4 classes, a class width of 2 hours, and a lower limit of 3 for class 1.

Hours	Frequency

MULTIPLE CHOICE. Choose the one alternative that best completes the statement or answers the question.

Construct the dotplot for the given data.

16) The following data represent the number of cars passing through a toll booth during a certain time period over a number of days.

38 39 37 37 44 38 41 38 39 35 42 39 43 37 41

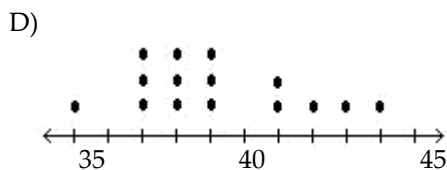
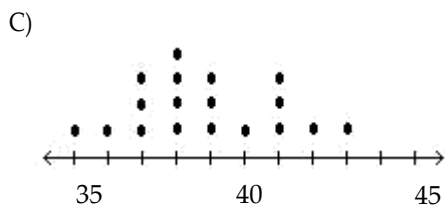
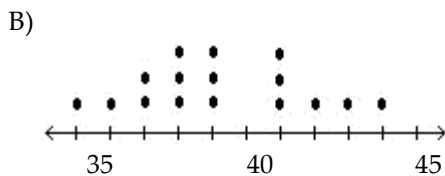
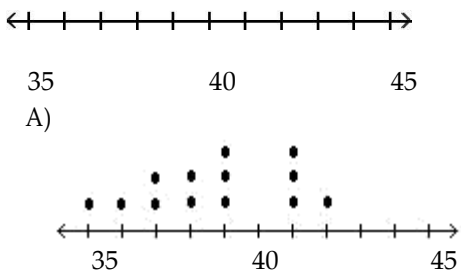

Provide an appropriate response.

17) The frequency distribution below summarizes employee years of service for Alpha Corporation. Determine the width of each class.

17) _____

Years of service	Frequency
1-5	5
6-10	20
11-15	25
16-20	10
21-25	5
26-30	3

A) 5

B) 6

C) 4

D) 10

SHORT ANSWER. Write the word or phrase that best completes each statement or answers the question.

18) Use the high closing values of Naristar Inc. stock from the years 1992 - 2003 to construct a time-series graph. (Let $x = 0$ represent 1992 and so on.) Identify a trend. _____

Year	High	Year	High
1992	48	1998	62
1993	53	1999	60
1994	47	2000	68
1995	55	2001	42
1996	58	2002	51
1997	61	2003	78

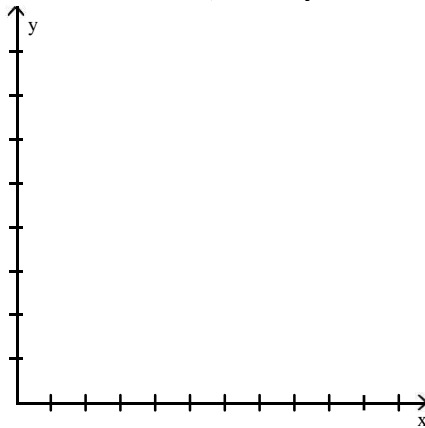

MULTIPLE CHOICE. Choose the one alternative that best completes the statement or answers the question.

Solve the problem.

19) Wagenlucht Ice Cream Company is always trying to create new flavors of ice cream. They are market testing three kinds to find out which one has the best chance of becoming popular. They give small samples of each to 20 people at a grocery store. 4 ice cream tasters preferred the Strawberry Cream, 12 preferred Choco-Nuts, and 4 loved the Orange Mint. Construct a Pareto chart to represent these preferences. Choose the vertical scale so that the relative frequencies are represented. _____

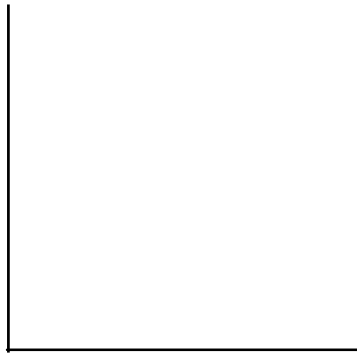

A)

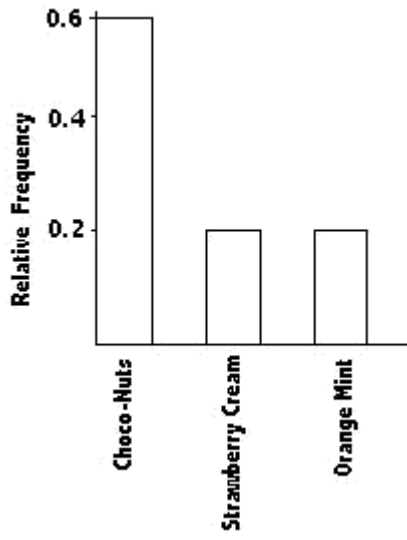

B)

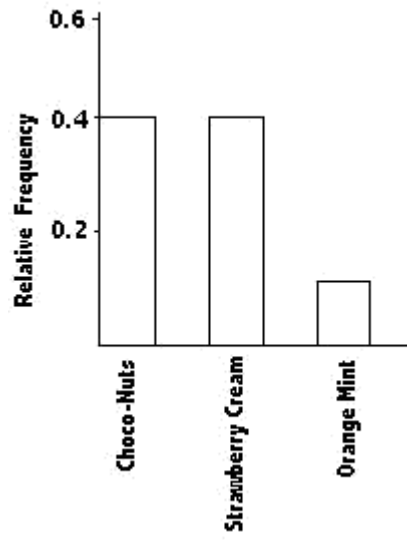

C)

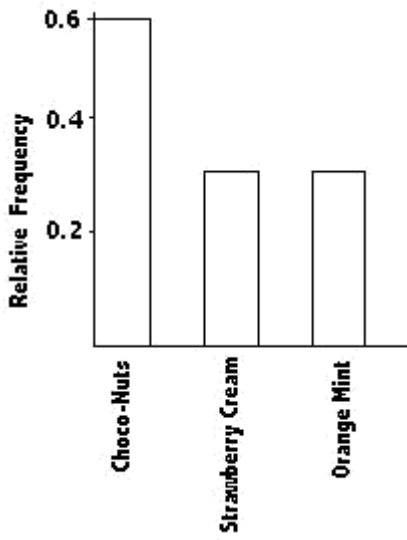

D)

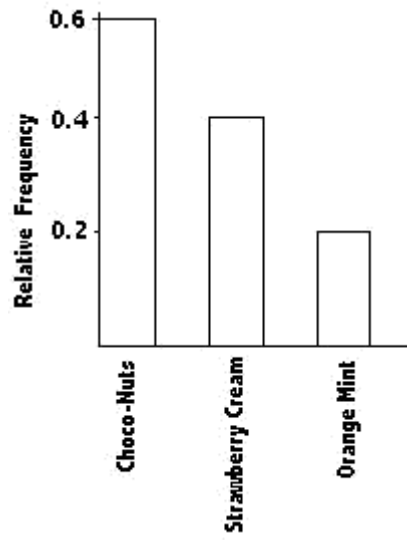

SHORT ANSWER. Write the word or phrase that best completes each statement or answers the question.

Provide an appropriate response.

- 20) The histogram below shows the distribution of the assets (in millions of dollars) of 71 companies. Does the distribution appear to be normal? 20) _____

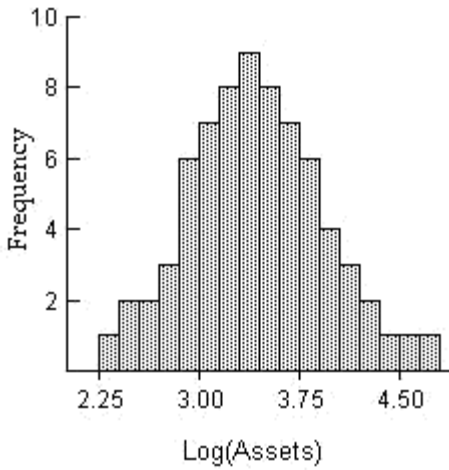

Use the given data to construct a frequency distribution.

- 21) A school district performed a study to find the main causes leading to its students dropping out of school. Thirty cases were analyzed, and a primary cause was assigned to each case. The causes included unexcused absences (U), illness (I), family problems (F), and other causes (O). The results for the thirty cases are listed below: 21) _____

U U U I F O O U I F
 F O U I I F I I O U
 I F F U U I I O F U

Construct a table summarizing the frequency distribution of the primary causes leading to student dropout.

Cause	Frequency

Solve the problem.

- 22) The frequency table below shows the amount of weight loss during the first month of a diet program for a group of men. Constructing a frequency polygon. Applying a loose interpretation of the requirements for a normal distribution, do the pounds of weight loss appear to be normally distributed? Why or why not? 22) _____

Weight (lb)	Frequency
5-7	2
8-10	9
11-13	18
14-16	13
17-19	4
20-22	1

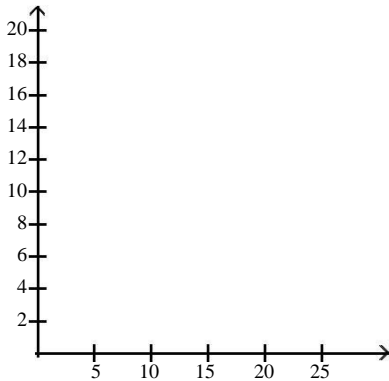

MULTIPLE CHOICE. Choose the one alternative that best completes the statement or answers the question.

Provide an appropriate response.

- 23) The frequency distribution below summarizes the home sale prices in the city of Summerhill for the month of June. Determine the class midpoint for class 235.0-265.9. 23) _____

(Sale price in thousand \$)	Frequency
80.0 - 110.9	2
111.0 - 141.9	5
142.0 - 172.9	7
173.0 - 203.9	10
204.0 - 234.9	3
235.0 - 265.9	1

- A) 250.40 B) 250.55 C) 250.45 D) 250.50

SHORT ANSWER. Write the word or phrase that best completes each statement or answers the question.

- 24) Explain in your own words why a bar graph can be misleading if one or both of the scales begin at some value other than zero. 24) _____

MULTIPLE CHOICE. Choose the one alternative that best completes the statement or answers the question.

Construct the cumulative frequency distribution that corresponds to the given frequency distribution.

25)

25) _____

Speed	Number of cars
0-29	4
30-59	16
60-89	60
90-119	20

A)

Speed	Cumulative Frequency
Less than 30	0.04
Less than 60	0.20
Less than 90	0.80
Less than 120	1.00

B)

Speed	Cumulative Frequency
Less than 30	4
Less than 60	20
Less than 90	80
Less than 120	100

C)

Speed	Cumulative Frequency
0-29	4
30-59	20
60-89	80
90-119	100

D)

Speed	Cumulative Frequency
Less than 30	100
Less than 60	80
Less than 90	82
Less than 120	4

Answer Key

Testname: CHAPTER 2 EXAM B

- 1) A
- 2) A
- 3) D
- 4) The approximate amount at the center is 16 magazines.

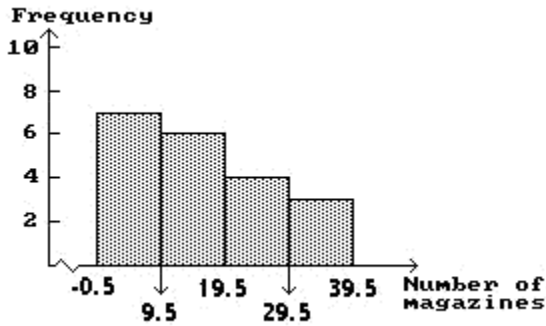

- 5) B
- 6) D
- 7) B
- 8) A
- 9) Since the range is $79 - 24 = 55$, and 55 divided by 5 equals 11, a whole number, the class width has to be widened from 11 to 12. If the class width was 11 data values equal to 79 would not be included in the frequency distribution.
- 10) A
- 11) A
- 12) A
- 13) C
- 14) A
- 15)

Hours	Frequency
3-4	3
5-6	13
7-8	7
9-10	1

- 16) D
- 17) A
- 18) Trend: Answers will vary. Possible answer: Except for a drop in high closing value in 1994, there was a steady rise through 2000, after which there was a sharp drop in 2001 followed by increases through 2003.

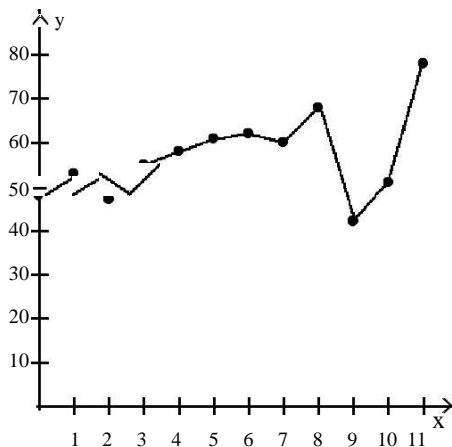

- 19) A

Answer Key

Testname: CHAPTER 2 EXAM B

20) Yes, it appears to be normal.

21)

Cause	Frequency
U	9
I	9
F	7
O	5

22) The frequency polygon appears to roughly approximate a normal distribution. The frequencies increase to a maximum and then decrease, and the graph is symmetric with the left half being roughly a mirror image of the right half.

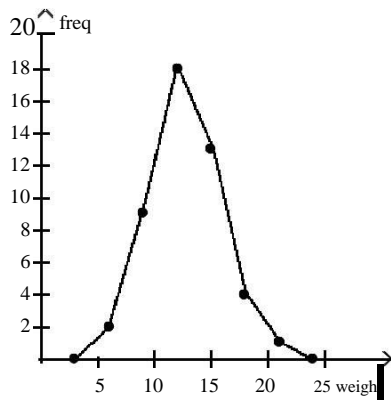

23) C

24) A bar graph with these characteristics exaggerates the differences in the data.

25) B